

RACK ROOM 2

MICE HALL

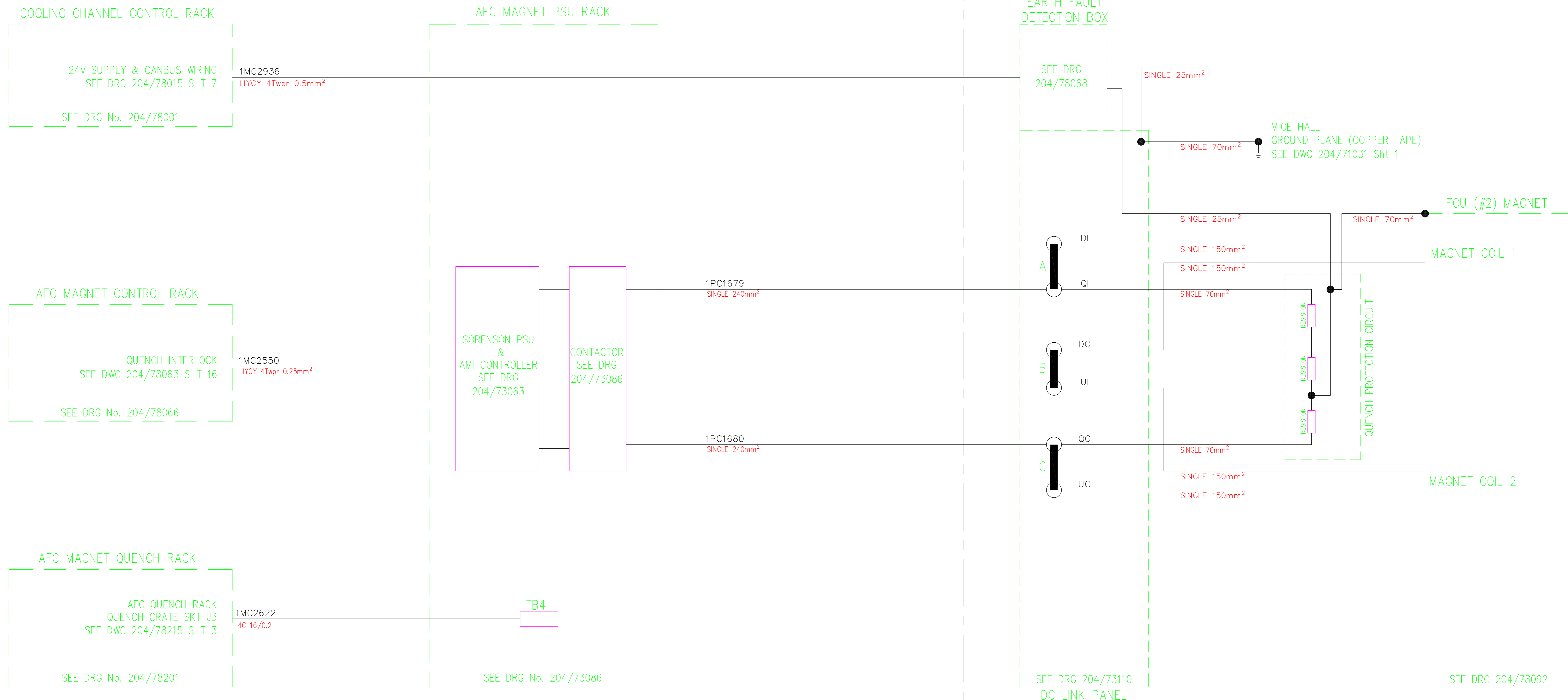

FCU STANDARD PSU/MAGNET SOLENOID MODE

A
FIRST
ISSUE

SCALE		0	
ALL DIMENSIONS IN MILLIMETERS UNLESS OTHERWISE STATED			
DRN	JWW	SCIENCE AND TECHNOLOGY FACILITIES COUNCIL	
DATE	DEC 2016	DARESBUURY LABORATORY	
CKD	T.Hartnett	CHESHIRE	
DATE	DEC 2016	TITLE	
CERT		MICE HALL	
DATE		FCU MAGNET/PSU	
APPD	T.Hartnett	SCHEMATIC WIRIG DIAGRAM	
DATE	DEC 2016	DRG No	AO-204/73089 SHT 1 OF 4
DRAWING LIST: - DL 204/73000		CAD PART No	204/73089
CONTRACTORS COMPANY		ISSUE	A
CONTRACTORS DRG No			

MICE HALL

QUENCH INTERFACE CRATE

FIELD WIRING DIAGRAM
SEE DRG 204-78215 SHT 1

1MC2556
18x0.5mm² UNITRONIC LIHCH

FIELD WIRING DIAGRAM
SEE DRG 204-78215
SHT 1 OR SHT 5

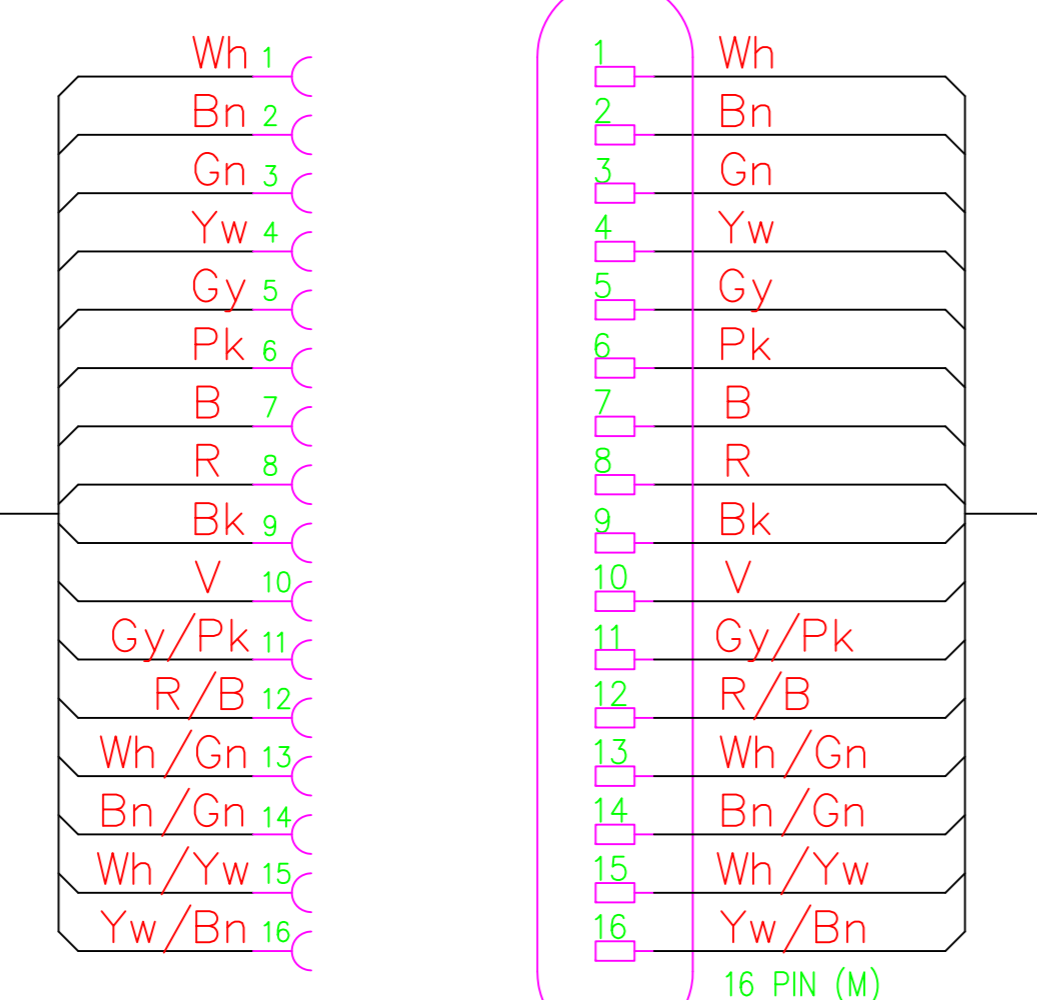

SOLENOID MODE
VOLTAGE TAPS 1 IN

SOLENOID MODE
VOLTAGE TAPS 2 IN

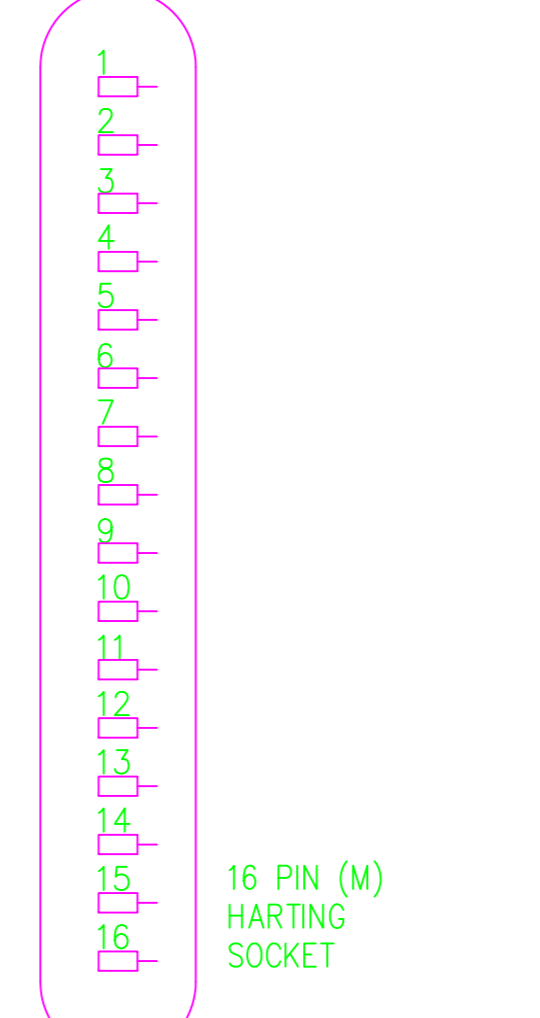

FLIP MODE
VOLTAGE TAPS 1 IN

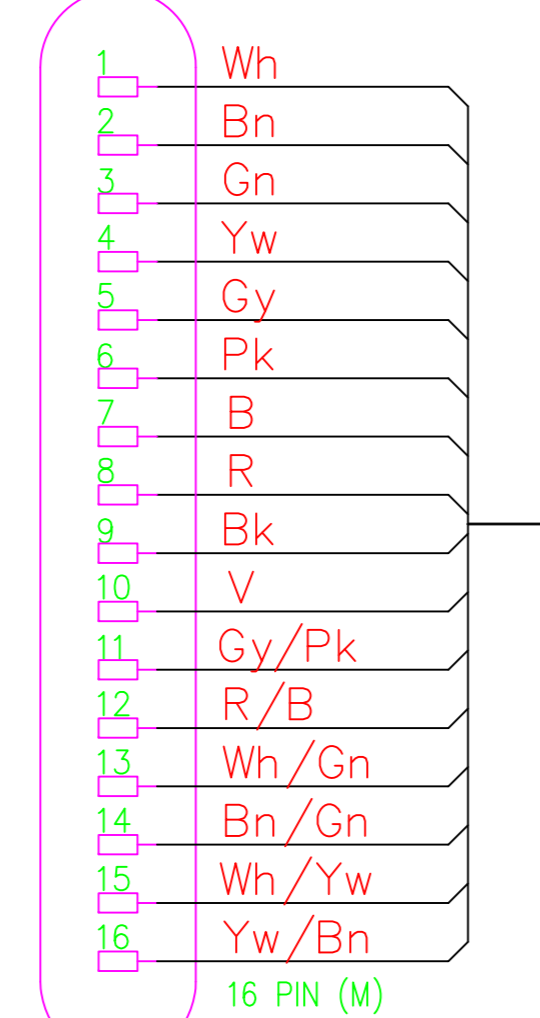

FLIP MODE
VOLTAGE TAPS 2 IN

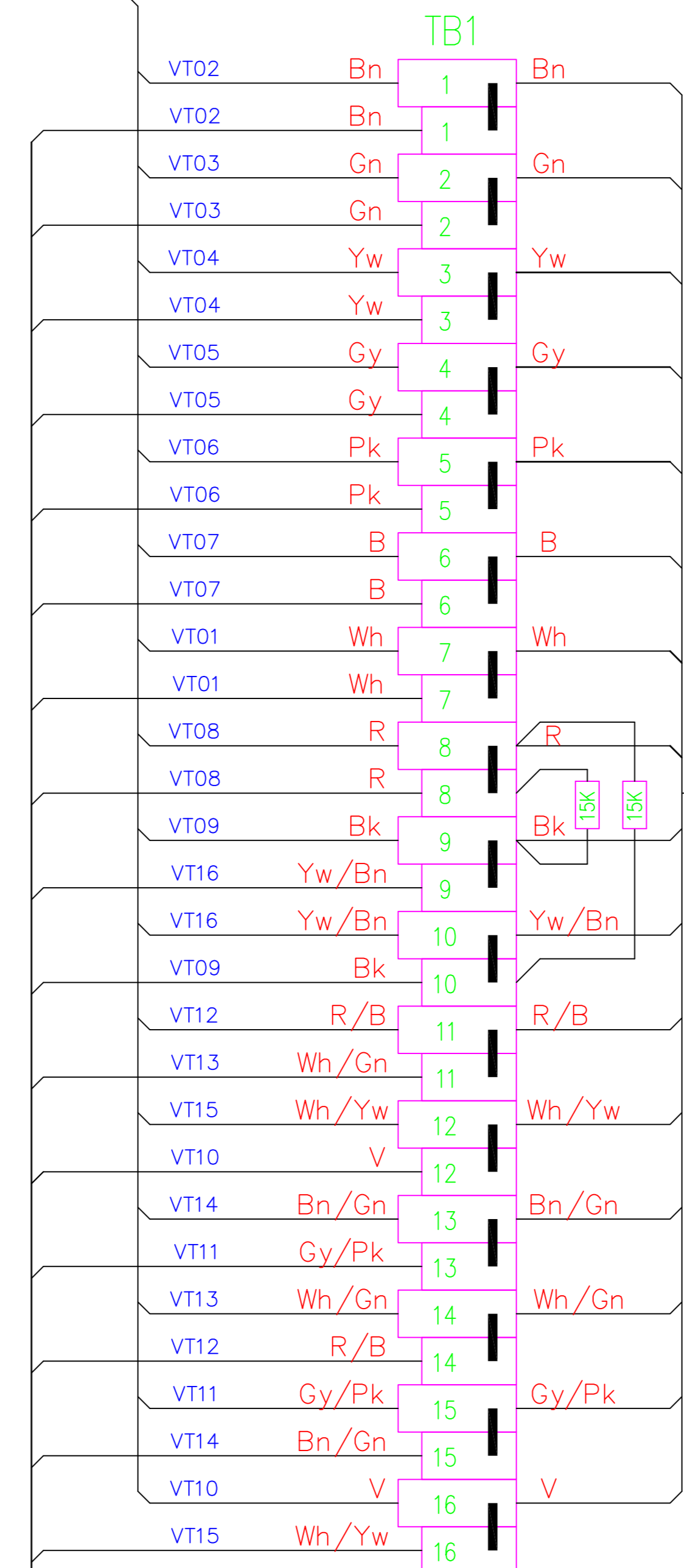
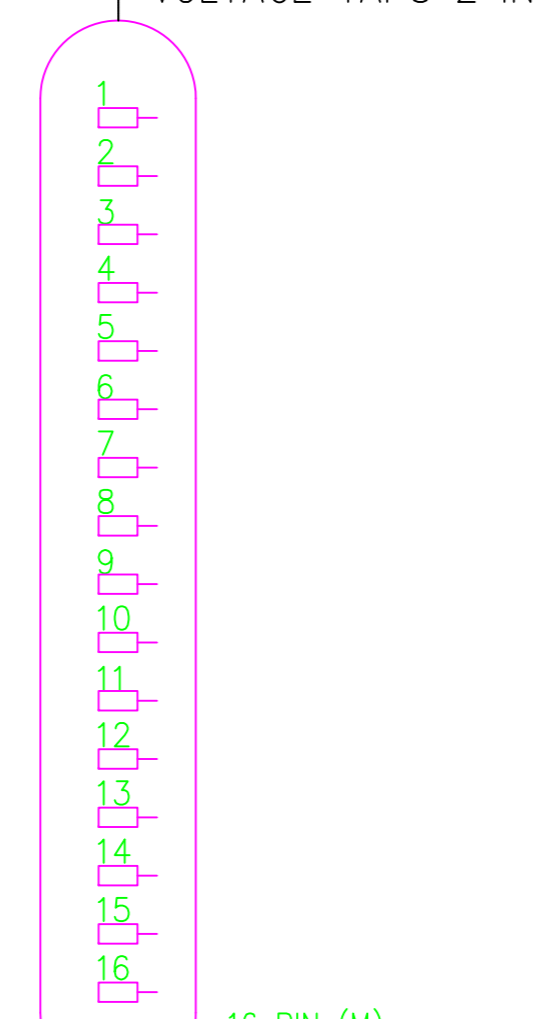

M25x1.5
POLYAMID
CABLE GLAND

(FCUQ/003 or FCDQ/003)
18x0.5mm² UNITRONIC LIHCH

A
FIRST
ISSUE

FCU STANDARD PSU/MAGNET SOLENOID MODE

SCALE		0	
ALL DIMENSIONS IN MILLIMETERS UNLESS OTHERWISE STATED			
DRN	JWW	SCIENCE AND TECHNOLOGY FACILITIES COUNCIL	
DATE	FEB 2015	DARESBURY LABORATORY	
CKD	T.Hartnett	CHESHIRE	
DATE	DEC 2016	TITLE	
CERT		MICE HALL	
DATE		FCU MAGNET/PSU	
		SCHEMATIC WIRING DIAGRAM	
APPD	T.Hartnett	DRG No	AO-204/73089
DATE	DEC 2016	SHT 2 OF 4	ISSUE A
DRAWING LIST: - DL 204/73000		CONTRACTORS DRG No	

RACK ROOM 2

MICE HALL

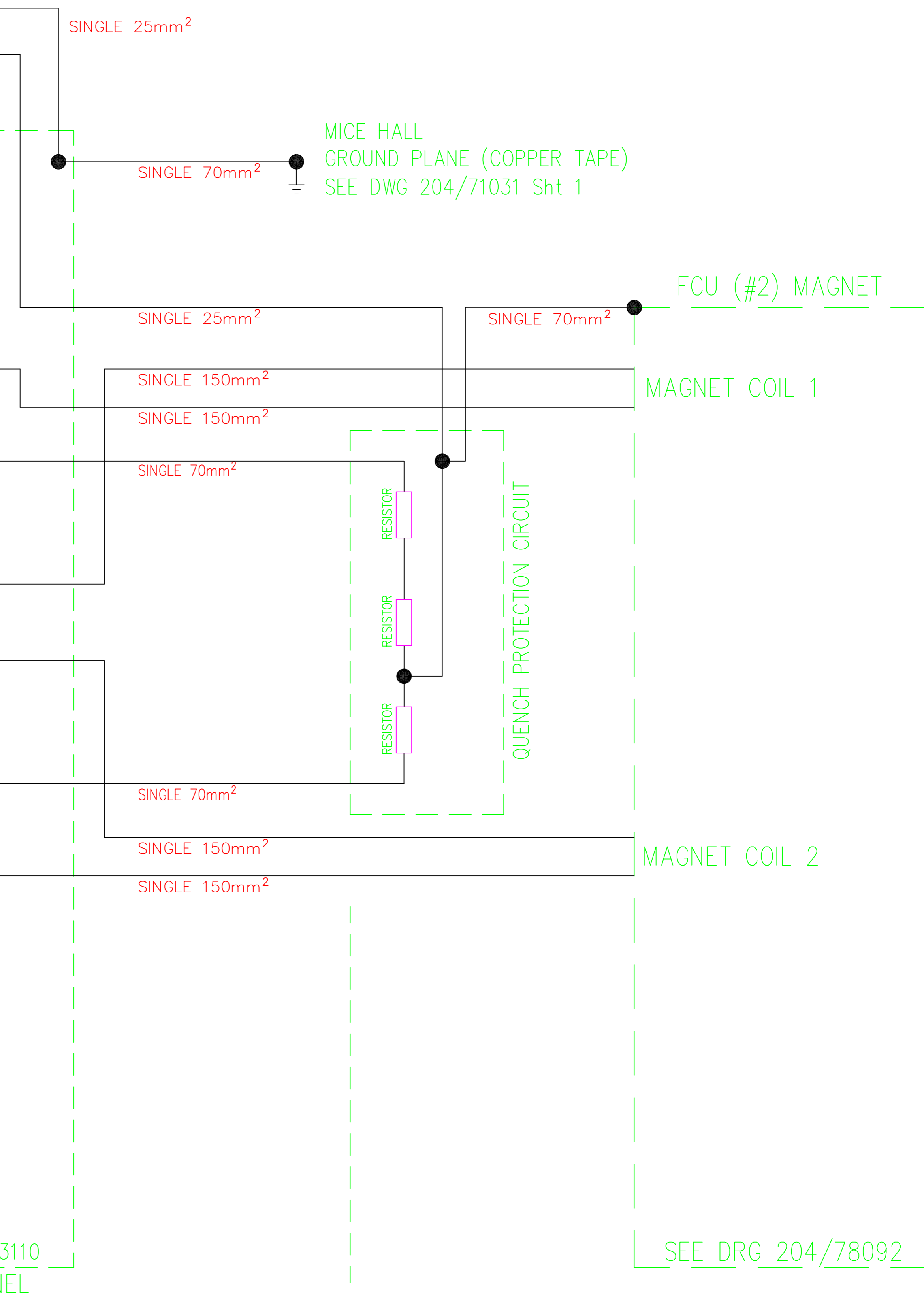
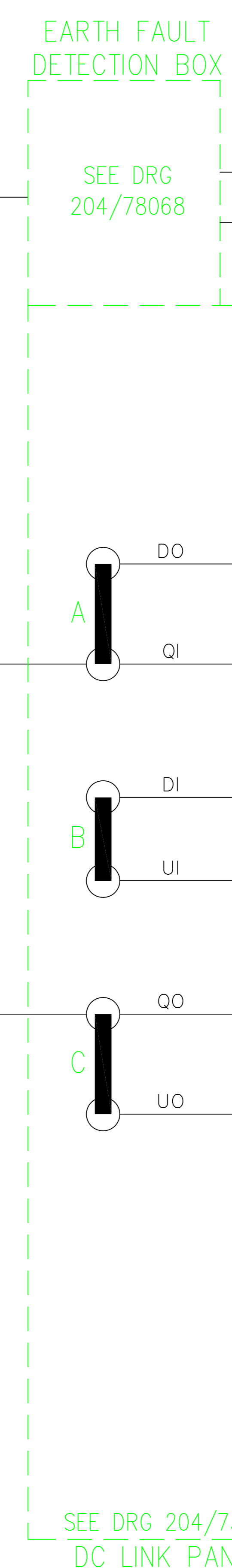
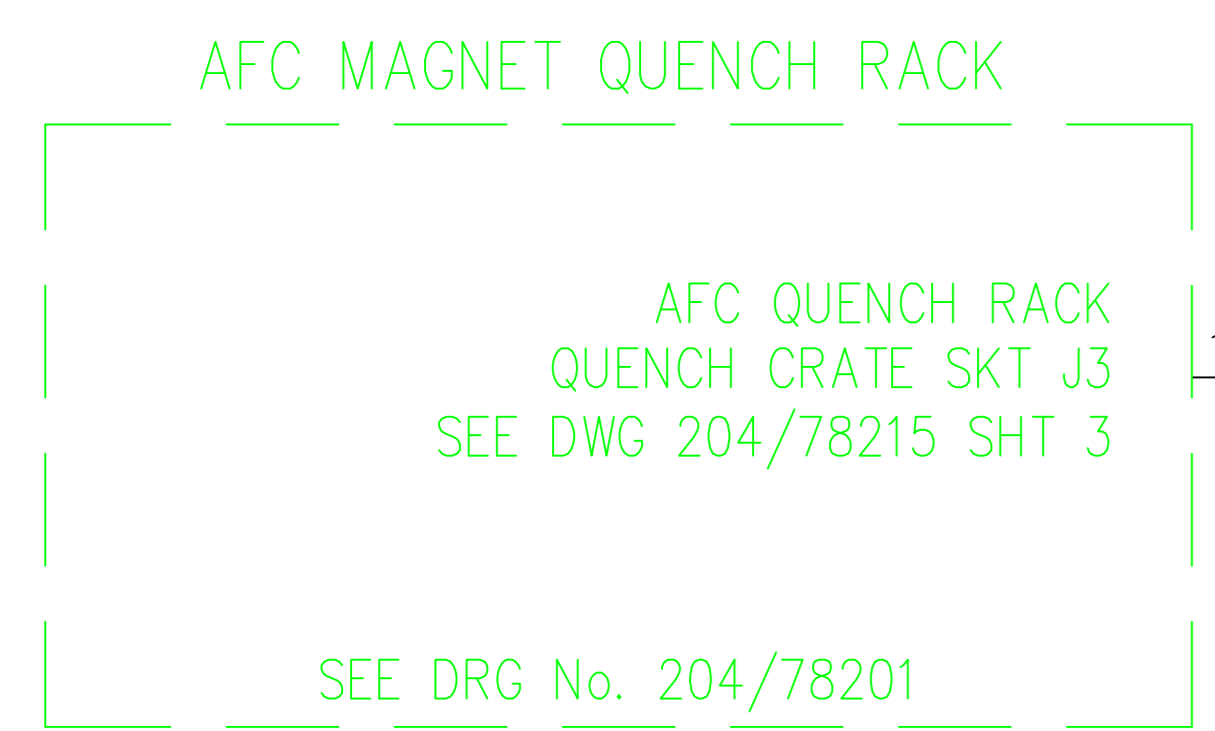
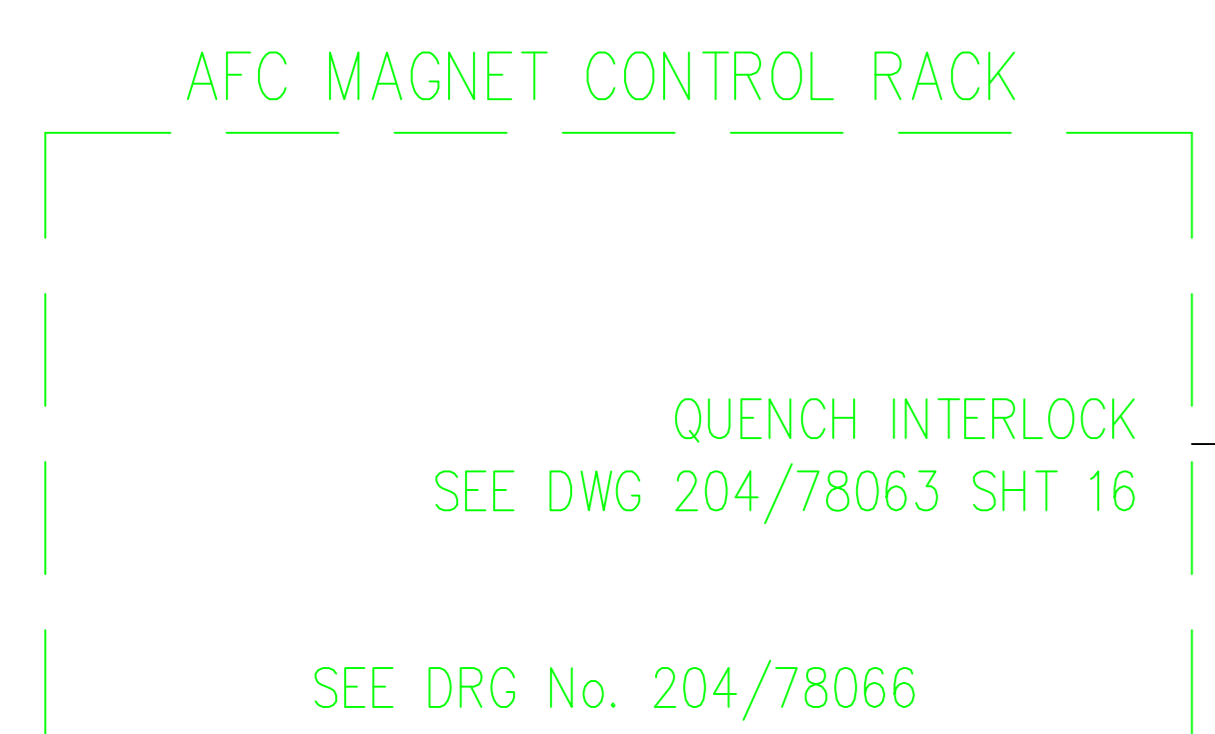
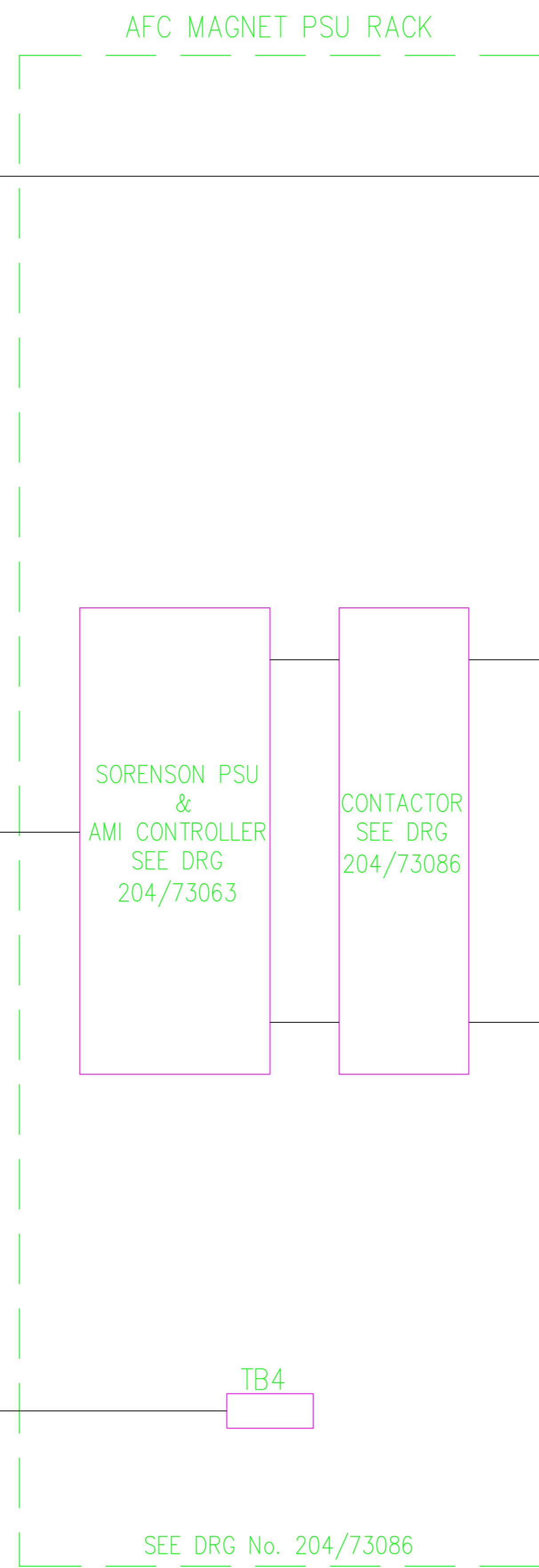

1MC2936
LIYCY 4Twpr 0.5mm²

1MC2550
LIYCY 4Twpr 0.25mm²

1MC2622
4C 16/0.2

1PC1679
SINGLE 240mm²

1PC1680
SINGLE 240mm²

SINGLE 25mm²

SINGLE 70mm²

SINGLE 25mm²

SINGLE 150mm²

SINGLE 150mm²

SINGLE 70mm²

SINGLE 70mm²

SINGLE 70mm²

SINGLE 150mm²

SINGLE 150mm²

A
FIRST
ISSUE

FCU STANDARD PSU/MAGNET FLIP MODE

SCALE		0	
ALL DIMENSIONS IN MILLIMETERS UNLESS OTHERWISE STATED			
DRN	JWW	SCIENCE AND TECHNOLOGY FACILITIES COUNCIL	
DATE	FEB 2015	DARESBUURY LABORATORY	
CKD	T.Hartnett	CHESHIRE	
DATE	2016	TITLE	
CERT		MICE HALL	
DATE		FCU MAGNET/PSU	
		SCHEMATIC WIRIG DIAGRAM	
APPD	T.Hartnett	DRG No	ISSUE
DATE	DEC 2016	AO-204/73089	SHT 3 OF 4
			A
DRAWING LIST: - DL 204/73000			
CONTRACTORS COMPANY			
CONTRACTORS DRG No			

MICE HALL

QUENCH INTERFACE CRATE

FOCUS COIL QUENCH RACK
QUENCH DETECTION CRATE

SOLENOID MODE
VOLTAGE TAPS 1 IN

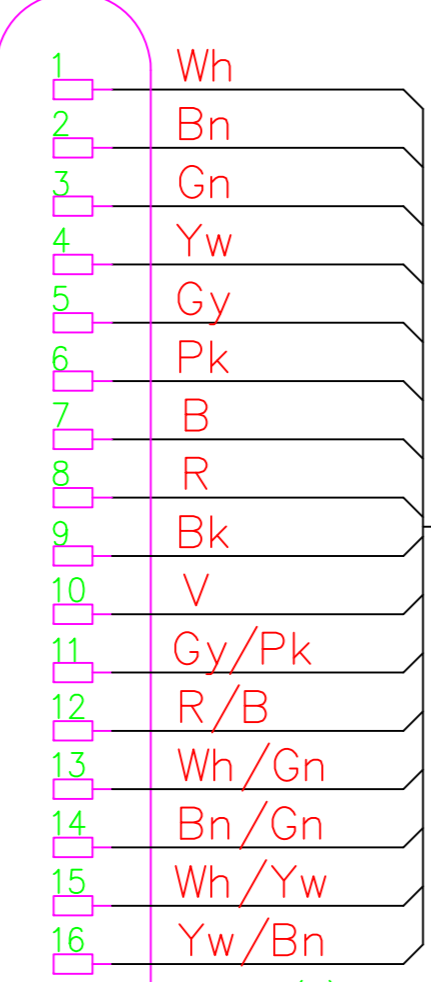

SOLENOID MODE
VOLTAGE TAPS 2 IN

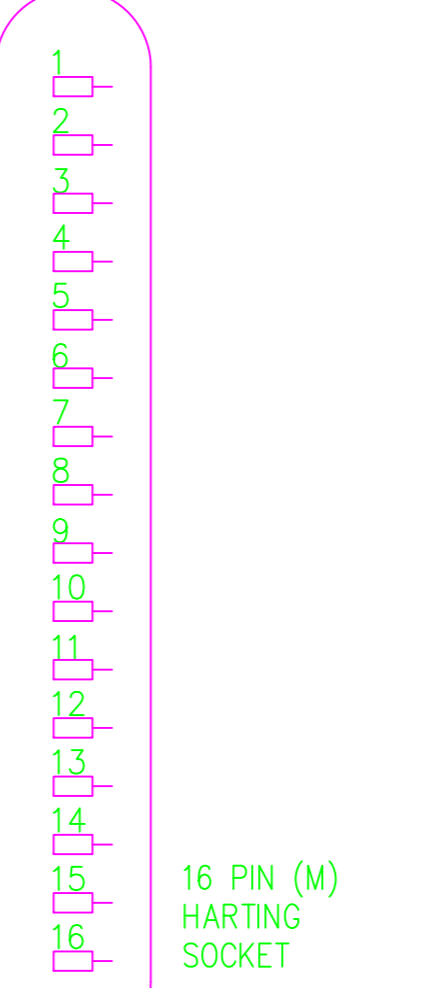

FLIP MODE
VOLTAGE TAPS 1 IN

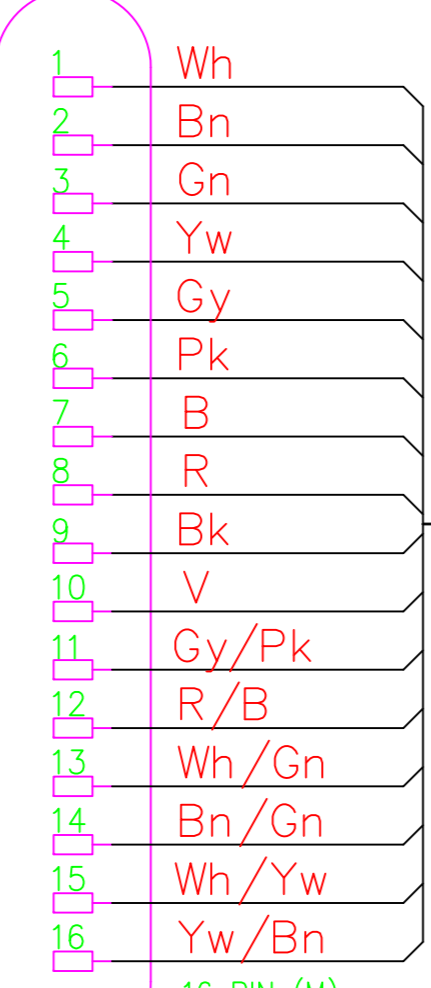
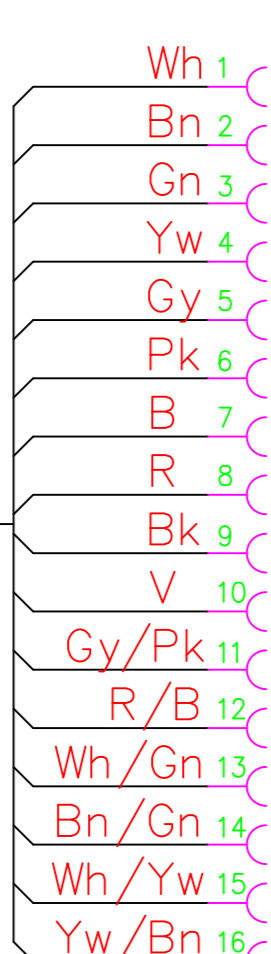

FLIP MODE
VOLTAGE TAPS 2 IN

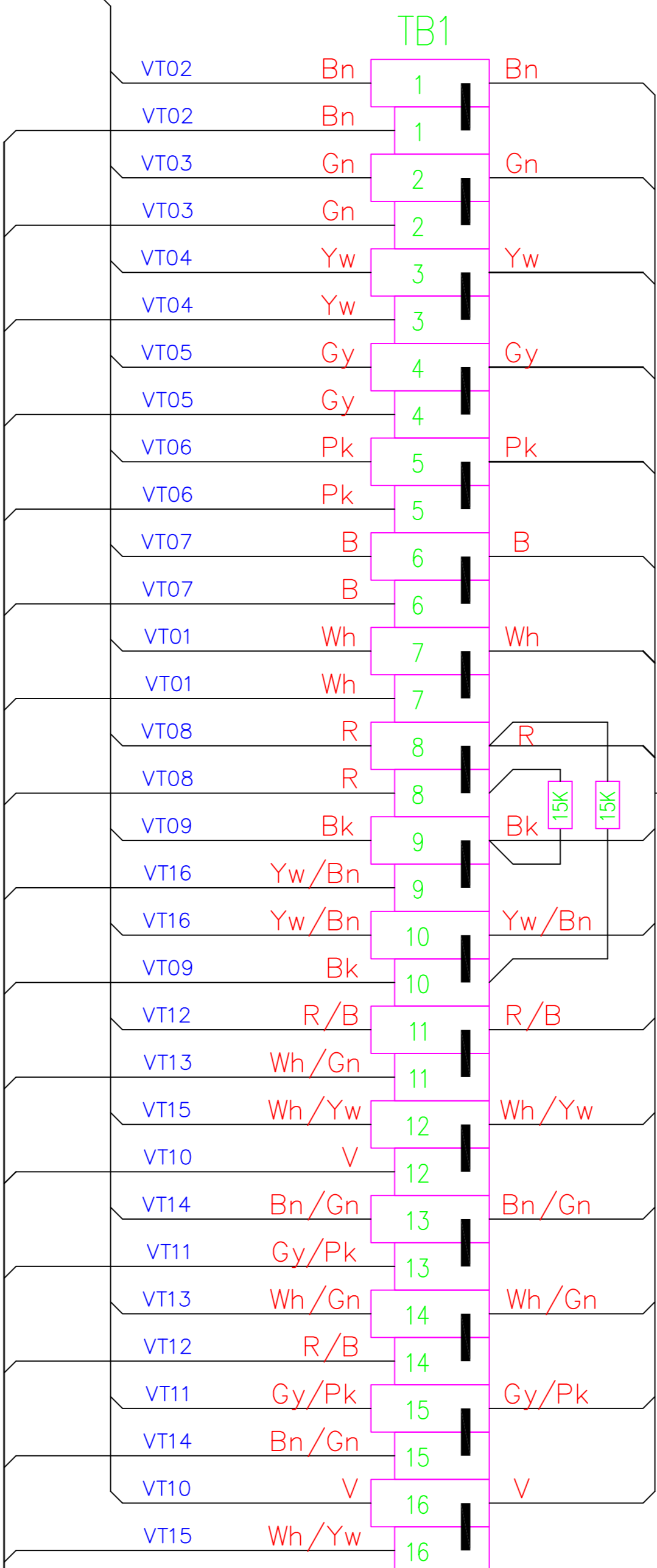
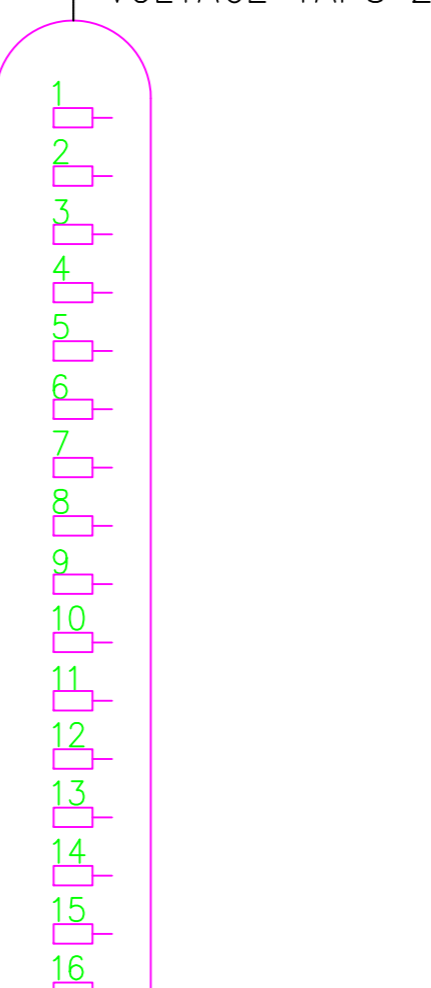

(FCUQ/003 or FCDQ/003)
18x0.5mm² UNITRONIC LIHCH

FIELD WIRING DIAGRAM
SEE DRG 204-78215
SHT 1 OR SHT 5

FIELD WIRING DIAGRAM
SEE DRG 204-78215 SHT 1

1MC2556
18x0.5mm² UNITRONIC LIHCH

FCU STANDARD PSU/MAGNET FLIP MODE

SCALE		0	
ALL DIMENSIONS IN MILLIMETERS UNLESS OTHERWISE STATED			
DRN	JWW	SCIENCE AND TECHNOLOGY FACILITIES COUNCIL	
DATE	FEB 2015	DARESBUURY LABORATORY	
CKD	T.Hartnett	CHESHIRE	
DATE	DEC 2016	TITLE	
CERT		MICE HALL	
DATE		FCU MAGNET/PSU	
		SCHEMATIC WIRING DIAGRAM	
APPD	T.Hartnett	DRG No	AO-204/73089
DATE	DEC 2016	SHT 4 OF 4	ISSUE
			A
DRAWING LIST: - DL 204/73000		CONTRACTORS DRG No	

A
FIRST
ISSUE